

HelioPower®

MAINTENANCE GUIDE

wright flow
TECHNOLOGIES®

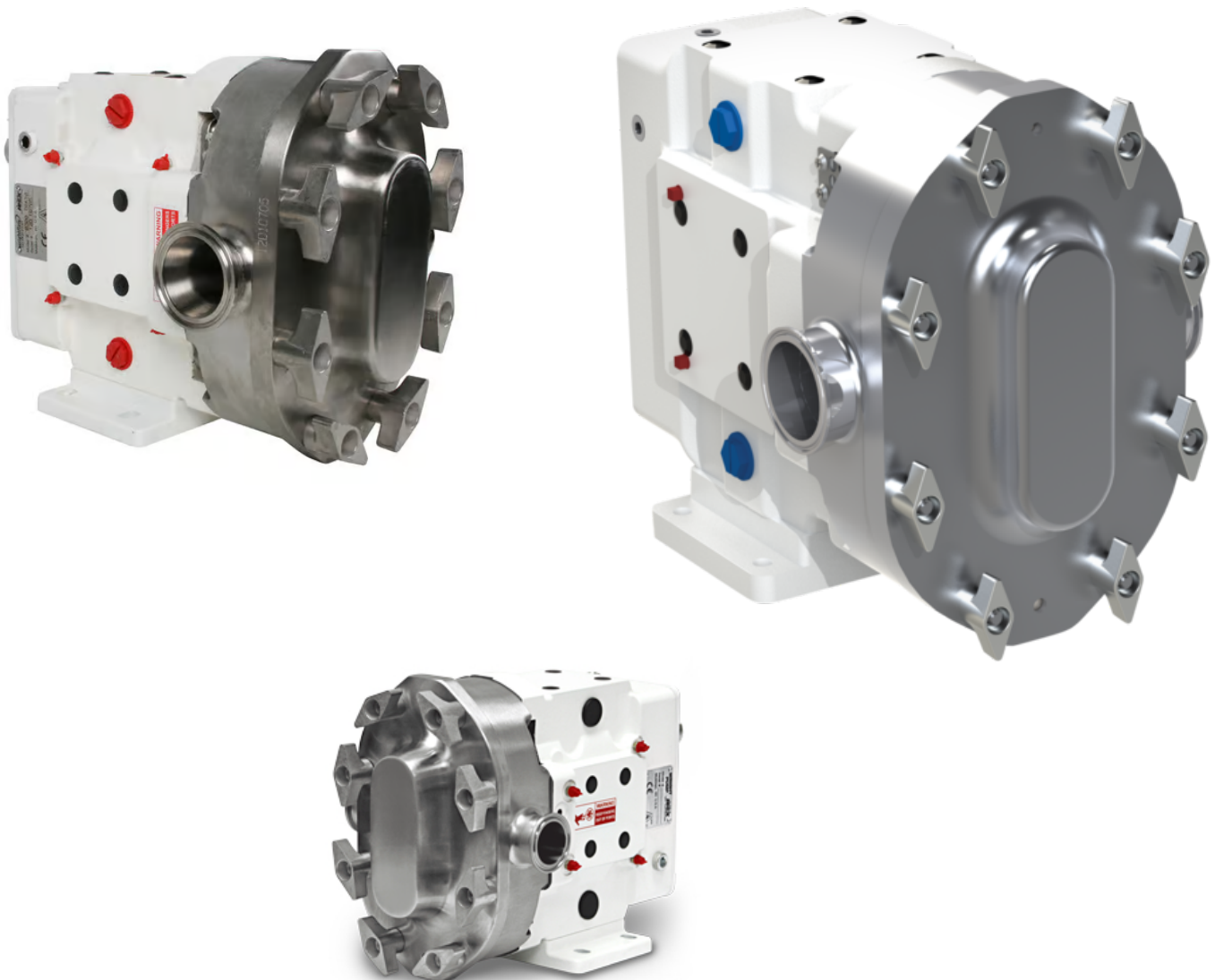



INSTALLATION, OPERATION & MAINTENANCE MANUAL

SANITARY POSITIVE DISPLACEMENT PUMPS TRA® 10 SERIES

SECTION	IOM TRA®10
PAGE	1 OF 22
ISSUE	G

CONTENTS

Introduction	1
General Information.	1
Safety Information.	2
Tools Required for Disassembly / Assembly	3
Normal Operation	3
Installation.	6
Startup Checklist	8
Cleaning and Maintenance	8
Pump Head and Seal Disassembly / Assembly.	10
Gear Box Disassembly / Assembly	11
Standard Clearances	13
Fastener Torque Range.	15
Care of Stainless Steel	17
Troubleshooting Guide	18
ATEX Pump Only Information.	19
Warranty	21

Replacement Labels:



Application Instructions: Apply to a clean, dry surface. Remove the backing from the label, place it in proper position, protect it with a cover sheet and burnish it. (A soft rubber roller also may be used to press the label into place.) Apply all labels to be readable from the front of the pump

Important:

1. Pump and drive are factory aligned.
2. Recheck alignment after installation and before start-up
3. Recheck alignment periodically, to maximize service life.

INTRODUCTION

Thank you for purchasing this Wright Flow Technologies model. To ensure the best possible service, read and understand this manual prior to installation, operation or maintaining this pump. For questions regarding installation, operation or maintenance, contact your distributor or Wright Flow Technologies.

GENERAL INFORMATION

Each Wright Flow Technologies product is shipped completely assembled and ready for use. Normal maintenance – as outlined in this manual – will provide long, trouble free service when the pumps is incorporated in a properly designed system.

Inspection at receipt: ports are covered at the factory to prevent dirt and foreign objects from entering the pump head. If port covers are damaged or missing, remove the pump cover to ensure the pump is clean and free of foreign objects or materials before rotating the shaft. If the pump is damaged in transit, file a claim with the carrier right away. The carrier has a Bill of Lading showing that the shipment was received from us in good condition.

Returns: when necessary to return a product under warranty or for any other reason, first contact Wright Flow Technologies to receive a Return Goods Authorization number to facilitate getting the product back to you as soon as possible.



**FIGURE 1
TRA® 10 SERIES**

Information contained in this manual is subject to change without notice and does not represent a commitment from IDEX Corporation.



SAFETY INFORMATION

INCORRECT INSTALLATION, OPERATION OR MAINTENANCE OF EQUIPMENT MAY CAUSE SEVERE PERSONAL INJURY OR DEATH AND/OR EQUIPMENT DAMAGE AND MAY INVALIDATE THE WARRANTY.

This information must be read fully before beginning installation, operation or maintenance and must be kept with the pump. All installation and maintenance must be undertaken by suitably trained or qualified persons only.

Symbol Legend :



Danger - Failure to follow the listed precautionary measures identified by this symbol may result in serious injury or death.

WARNING

Warning - Safety instructions which shall be considered for reasons of safe operation of the pump or pump unit and/or protection of the pump or pump unit itself are marked by this symbol.

	DO NOT OPERATE PUMP IF:	WARNING	Pressure gauges/sensors are recommended, next to the pump suction and discharge connections to monitor pressures.
	<ul style="list-style-type: none"> - The front cover is not installed correctly. - Any guards are missing or incorrectly installed. - The suction or discharge piping is not connected. 		Caution must be taken when lifting the pump. Suitable lifting devices should be used as appropriate. Lifting eyes installed on the pump must only be used to lift the pump, not pump with drive and/or baseplate. If pump is baseplate mounted, the base plate must be used for all lifting purposes. If slings are used for lifting, they must be safely and securely attached. For weights of bare shaft pumps refer to catalog.
	DO NOT place fingers, etc. into the pumping chamber or its connection ports or into any part of the drive train if there is ANY possibility of the pump shafts being rotated. Severe injury will occur.		DO NOT attempt any maintenance or disassembly of the pump or pump unit without first ensuring that :
	DO NOT exceed the pumps rated pressure, speed, and temperature, or change the system/duty parameters from those for which the pump was originally supplied, without confirming its suitability for the new duty.		<ul style="list-style-type: none"> - The pump is fully isolated from the power source (electric, hydraulic, pneumatic).
	INSTALLATION AND OPERATION OF THE PUMP MUST ALWAYS COMPLY WITH HEALTH AND SAFETY REGULATIONS.		<ul style="list-style-type: none"> - The pumping chamber, relief valve and any shaft seal support system are depressurized and purged.
WARNING	A device must be incorporated into the pump, system, or drive to prevent the pump exceeding its stated duty pressure. It must be suitable for both directions of pump rotation where applicable. Do not allow pump to operate with a closed/blocked discharge unless a pressure relief device is incorporated. If an integral relief valve is incorporated into the pump, do not allow re-circulation through the relief valve for extended periods.		<ul style="list-style-type: none"> - Any temperature control devices (jackets, heat-tracing, etc) are fully isolated, that they are depressurized and purged, and components are allowed to reach a safe handling temperature.
	The mounting of the pump or pump unit should be solid and stable. Pump orientation must be considered in relation to drainage requirements. Once mounted, shaft drive elements must be checked for correct alignment. Rotate pump shaft by at least one full revolution to ensure smoothness of operation. Incorrect alignment will produce excessive loadings and will create high temperatures and increased noise emissions.		DO NOT attempt to dismantle a pressure relief valve which has not had the spring pressure relieved or is mounted on a pump that is operating. Serious personal injury or death and/or pump damage may occur.
			DO NOT loosen or undo the front cover, any connections to the pump, shaft seal housings, temperature control devices, or other components, until sure that such action will not allow the unsafe escape of any pressurized media.
			Pumps and/or drives can produce sound power levels exceeding 85 dB(A) under certain operating conditions. When necessary, personal protection against noise must be taken.
	The installation must allow safe routine maintenance and inspection (to check for leakage, monitor pressures, etc) and provide adequate ventilation necessary to prevent overheating.		Avoid any contact with hot parts of pumps and/or drives which may cause injury. Certain operating conditions, temperature control devices (jackets, heat-tracing, etc.), bad installation, or poor maintenance can all promote high temperatures on pumps and/or drives.
WARNING	Before operating the pump, be sure that it and all parts of the system to which it is connected are clean and free from debris and that all valves in the suction and discharge pipelines are fully opened. Ensure that all piping connecting to the pump is fully supported and correctly aligned with its relevant connections. Misalignment and/or excess loads will cause severe pump damage.		When cleaning, either manually or by CIP method, the operator must ensure that a suitable procedure is used in accordance with the system requirements. During a CIP cleaning cycle, a pump differential pressure of between 30 and 45 psi is recommended to ensure suitable velocities are reached within the pump head. The exterior of the pump should be cleaned periodically.
	Be sure that pump rotation is correct for the desired direction of flow.		
WARNING	DO NOT INSTALL THE PUMP INTO A SYSTEM WHERE IT WILL RUN DRY (I.E. WITHOUT A SUPPLY OF PUMPED MEDIA).	WARNING	

TOOLS REQUIRED FOR DISASSEMBLY / ASSEMBLY

1. "O" ring removal tool—supplied with pump
2. Rotor nut wrench—supplied with pump
3. Soft-faced hammer
4. Suitable gear puller
5. Allen wrenches
6. Hydraulic press
7. Suitable V blocks
8. Measuring tools
9. Spanner wrenches for gear end lock nuts—available from Wright Flow Technologies
 - WT0150SPWRENCH • WT0600SPWRENCH
 - WT0300SPWRENCH • WT2200SPWRENCH

NORMAL OPERATION

Normal operation of most Wright Flow TRA® 10 Series pumps is within a range of 0 to 600 rpm, with a pressure range of 0 to 200 psi. Standard rotors operate within a temperature range of -40°F to 200°F. Hot clearance rotors operate at 200°F to 300°F. Consult factory for operation at other values. Refer to Table 1.

Pump Characteristics:

Wright Flow Technologies TRA10 pumps are positive-displacement, low-slip, stainless steel pumps designed with larger diameter shafts for greater strength and stiffness, mounted on a heavy-duty cast iron bearing frame (stainless steel option available) with double tapered roller bearings.

- Up to 200 psi (13.8 bar) pressure capability.
- No bearings in the product zone.
- Heavy-duty bearing frame with large diameter shafts.
- Greased lubed bearings for positive lubrication to all bearings over entire speed, temperature and pressure range.
- Non-galling ASTM A-494 rotors are standard; permits running at tighter clearances and pumping a wide range of viscosities.

GENERAL

TRA10 Pumping Principal:

The pumping action is generated by the counter-clockwise rotation of two pumping elements (rotors) within a chamber (rotorcase) - see Figure 2. The rotors are located on shafts, which in turn are mounted within an external gearbox and supported by the bearings; the timing gears are also located on the shafts. The timing gears transfer the energy from the drive shaft to the driven shaft, synchronising the rotors such that they rotate without contact with each other.

As the rotors pass the inlet port, see Figure 2, the cavity generated increases creating a pressure decrease, which induces the pumped medium to flow into the rotorcase.

The pumped medium is carried around the rotorcase by the rotors to the discharge side of the pump, here the cavity decreases and the pumped medium is discharged from the rotorcase.

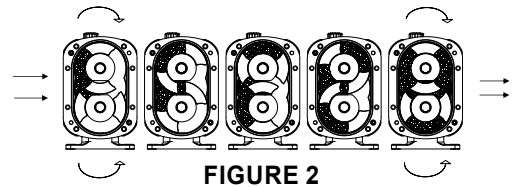

FIGURE 2

TRA10 Range Operating Parameters:

The maximum pressure and speed operating parameters are given in Pump Performance Tables 2 & 2A. In practice these may be limited due to the nature of the product to be pumped and/or design of the system in which the pump is to be installed. Consult Wright Flow Technologies or your Wright Flow Technologies distributor for assistance.

The operating temperature limit of the pump is determined by the rotor clearance.

For the circumferential piston pumps (CPP):

- TRA10 Series - four rotor clearance bands:
 - a) Standard
 - b) FF (Front Face)
 - c) Hot
 - d) Extra (Hot Chocolate)

The pump should not be subjected to sudden temperature changes to avoid the risk of damage from sudden expansion/contraction of components. Care should be taken when selecting pumps for handling liquids containing abrasive particles as these may cause wear of pump head components.

TRA10 Series	Liquid Operating Temperature Limit °C (°F)			
	Standard	FF	Hot	Extra
Circumferential Piston	93°C (200°F)	105°C (221°F)	150°C (302°F)	See Note

NOTE: "Extra" clearance rotors are another available option from Wright Flow Technologies. "Extra" clearance rotors are recommended for use with products such as peanut butter or chocolate. These products tend to "plate out" and build up on rotor surfaces. Extra clearance rotors require special selection procedures. Contact Wright Flow Technologies Application Engineering for assistance.

TABLE 1

⚠ WARNING !

The Net Positive Suction Head available (NPSHa) from the system must always exceed the Net Positive Suction Head required (NPSHr) by the pump.

Observing the following general guidelines should ensure the best possible suction condition is created.

- Suction piping is at least the same diameter as the pump connections.
- The length of suction piping is kept to the absolute minimum.
- The minimum number of bends, tees and pipework restrictions are used.
- Calculations to determine system NPSHa are carried out for the worst condition, see below.

Should advice on pump or system NPSH characteristics be required contact the factory or their authorised distributor.

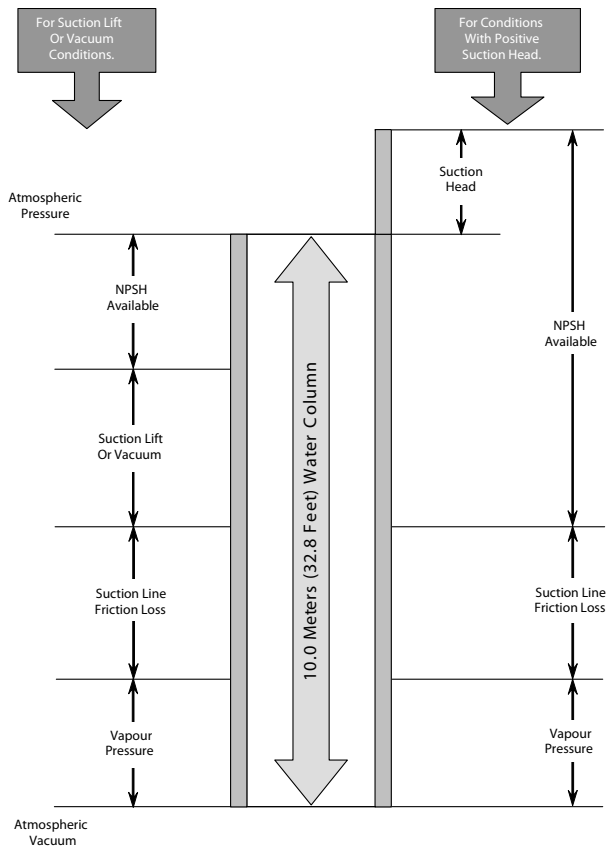

INSTALLATION POSITIONS

4-Way Mounting

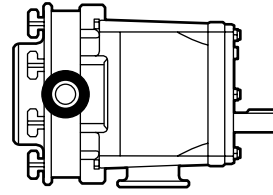

Horizontal ports,
bottom shaft position

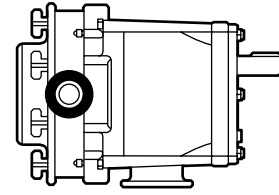

Horizontal ports,
top shaft position

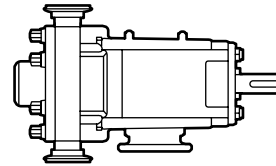

Vertical ports, left-hand
or right-hand shaft position

TRA[®]10 PUMP PERFORMANCE

TRA [®] 10 Model	Nominal Capacity		Displacement per Revolution		Maximum Pressure		Liquid Temperature Range		Standard Ports		Optional Ports		Maximum Speed (RPM)
	GPM	M ³ /hr	Gal.	Liter	PSI	Bar	Deg. F	Deg. C	in.	mm	in.	mm	
0060	6.0	1.3	0.008	0.030	200	14	-40° to 300°	-40° to 150°	1.5	38	1.0	25.4	800
0150	9.0	2.0	0.014	0.052	200	14	-40° to 300°	-40° to 150°	1.5	38	—	—	700
0180	17.0	3.8	0.03	0.11	200	14	-40° to 300°	-40° to 150°	1.5	38	2.0	51.0	600
0300	36.0	8.2	0.06	0.23	200	14	-40° to 300°	-40° to 150°	1.5	38	2.0	51.0	600
0450*	59.0	13.3	0.10	0.38	400	27	-40° to 300°	-40° to 150°	2.0	51	—	—	600
0600	90.0	20.4	0.15	0.58	200	14	-40° to 300°	-40° to 150°	2.5	64	3.0	76.0	600
1300	150.0	34.1	0.25	0.96	200	14	-40° to 300°	-40° to 150°	3.0	76	4.0	102.0	600
2200	310.0	70.4	0.52	1.98	200	14	-40° to 300°	-40° to 150°	4.0	102	—	—	600
3200	450.0	102.0	0.75	2.85	200	14	-40° to 300°	-40° to 150°	6.0	152	—	—	600



(Example of Rectangular Flange model)

TABLE2-PUMPPERFORMANCEPARAMETERS

TRA [®] 10 Rectangular Flange Model	Nominal Capacity		Displacement per Revolution		Maximum Pressure		Liquid Temperature Range		Inlet (W x L)		Outlet		Maximum Speed (RPM)
	GPM	M ³ /hr	Gal.	Liter	PSI	Bar	Deg. F	Deg. C	in.	mm	in.	mm	
0240	11.6	2.5	0.03	0.11	200	14	-40° to 300°	-40° to 150°	1.31 x 4.93	33.27 x 125.22	1.5	38.1	400
0340	24.0	5.4	0.06	0.22	200	14	-40° to 300°	-40° to 150°	1.75 x 6.75	44.50 x 171.45	2.0	50.8	400
0640	60.0	13.6	0.15	0.57	200	14	-40° to 300°	-40° to 150°	2.24 x 8.82	56.90 x 224.03	2.5	57.2	400
1340	100.0	22.7	0.25	0.96	200	14	-40° to 300°	-40° to 150°	2.97 x 9.25	75.44 x 234.95	3.0	76.2	400
2240	200.0	45.4	0.52	1.97	200	14	-40° to 300°	-40° to 150°	3.87 x 11.00	98.30 x 279.40	4.0	101.6	400

TABLE 2A - PUMP PERFORMANCE PARAMETERS - RECTANGULAR FLANGE MODELS

PORTCONFIGURATIONS

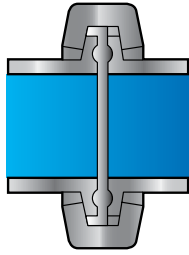

Standard Sanitary Clamp (Triclamp)

Other port configuration options include:

- DIN 11851
- 150# or 300# flange
- RJT
- Rectangular inlet flange
- NPT
- ACME
- SMS

PERFORMANCERANGE

- **Capacity Range:**
0.1 to 450 gpm (0.02 to 102 m³/hr)
- **Pressure Range:**
to 200 PSI/14 Bar
* Model 0450 to 400 PSI/27 Bar
- **Liquid Temperature Range:**
-40°F to +300°F (-40°C to +150°C)
Note: Hot clearances required for high temp operation
- **Viscosity Range:**
28 to 910,000 SSU (1 to 200,000 cPs)
Note: Consult factory for applications greater than 910,000 SSU/200,000 cSt. Chocolate clearances available.

TRA[®]10 DIMENSIONS

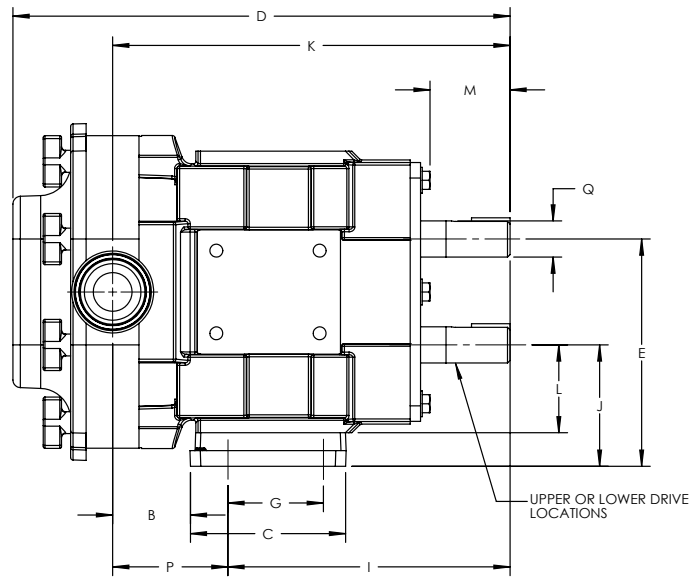
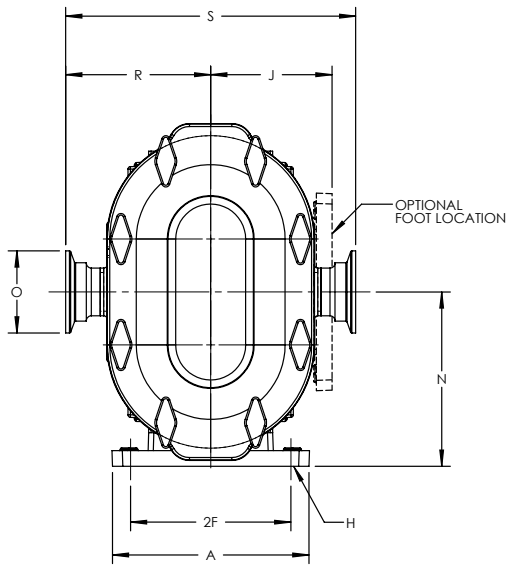

Model		A	B	C	D	E	F	G	H	I	J	K	L	M	N	O	P	Q Ø	R	S	Weight
0060	in.	4.75	2.34	3.20	12.04	5.50	1.94	2.31	0.375 x 0.31 (slot)	6.82	2.93	9.61	1.81	2.00	4.21	1.50	2.79	0.875	3.49	6.97	53 lb.
	mm	121	59	81	303	140	49	59	9.5 x 8 (slot)	173	74	244	46	51	107	38	71	22.23	89	177	24 kg
0150	in.	4.75	2.34	3.20	12.04	5.50	1.94	2.31	0.375 x 0.31 (slot)	6.82	2.93	9.61	1.81	2.00	4.21	1.50	2.79	0.875	3.49	6.97	53 lb.
	mm	121	59	81	303	140	49	59	9.5 x 8 (slot)	173	74	244	46	51	107	38	71	22.23	89	177	24 kg
0180	in.	4.75	2.34	3.20	12.46	5.50	1.94	2.31	0.375 x 0.31 (slot)	6.82	2.93	9.84	1.81	2.00	4.21	1.50	3.02	0.875	3.55	7.09	53 lb.
	mm	121	59	81	316	140	49	59	9.5 x 8 (slot)	173	74	250	46	51	107	38	77	22.23	90	180	24 kg
0300	in.	6.25	2.78	4.25	14.52	6.86	2.42	2.56	0.438 x 0.44 (slot)	7.77	3.56	11.61	2.62	2.32	5.21	1.50	3.84	1.250	4.25	8.50	99 lb.
	mm	159	71	108	369	174	61	65	11 x 11 (slot)	197	90	295	67	59	132	38	98	31.75	108	216	45 kg
0450	in.	8.25	4.14	5.87	18.91	9.56	3.50	4.12	0.56 x 0.50 (slot)	10.14	5.06	15.42	3.50	2.15	7.31	2.00	5.28	1.625	5.38	10.75	290 lb.
	mm	210	105	149	480	243	89	105	14 x 13 (slot)	258	129	392	89	55	186	51	134	41.28	136	273	132 kg
0600	in.	8.25	4.14	5.87	18.73	9.56	3.50	4.12	0.56 x 0.50 (slot)	10.14	5.06	15.14	3.50	2.15	7.31	2.50	5.00	1.625	5.37	10.75	290 lb.
	mm	210	105	149	480	243	89	105	14 x 13 (slot)	258	129	385	89	55	186	63	127	41.28	136	273	132 kg
1300	in.	8.25	4.79	5.87	19.66	9.56	3.50	4.12	0.56 x 0.50 (slot)	10.12	5.06	15.77	3.50	2.15	7.31	3.00	5.65	1.625	5.37	10.75	312 lb.
	mm	210	122	149	499	243	89	105	14 x 13 (slot)	257	129	401	89	55	186	76	144	41.28	136	273	142 kg
2200	in.	8.50	5.07	9.0	23.29	12.38	3.75	7.25	0.56 x 0.19 (slot)	12.74	6.38	18.49	4.50	2.63	9.38	4.00	5.75	2.000	6.63	13.25	555 lb.
	mm	216	129	229	592	314	95	184	14 x 5 (slot)	324	162	470	114	67	238	102	146	50.80	168	337	252 kg
3200	in.	12.00	4.12	11.63	30.17	13.88	5.25	8.00	0.66 Ø	16.55	6.88	21.92	5.06	4.06	10.38	6.00	5.37	2.375	8.00	16.00	1050 lb.
	mm	305	105	295	766	353	133	203	16 Ø	420	175	557	129	103	264	152	136	60.45	203	406	477 kg

EQUIPMENT SERIAL NUMBER

All Wright Flow Technologies pumps are identified by a serial number on the gear case nameplate, which is stamped on the pump body and cover.



CAUTION !

The gear case, body, and cover must be kept together as a unit due to backface, rotor, and cover clearances. Failure to do so will damage the pump.

INSTALLATION

Installation should follow good practice to provide the best performance and must meet local code requirements. All system components must be correctly sized to provide satisfactory operation of your Wright Flow Technologies product.

Consideration must be given to the following in order to achieve proper installation:

1. Pumps of this type are usually mounted on a base plate common with the drive unit. Bases may be permanently mounted, be self-leveling with vibration isolation pads, have adjustable legs or be portable. Bases should be level during pump operation.
2. Provide power as required by the motor and controls as needed for system operation.



WARNING !

Electrical connections must be made by a registered electrician in accordance with local codes and standards.



WARNING !

To avoid serious injury or death, do not install or service pump unless power is off and locked out.

3. Piping should be supported independently of the pump to prevent mis-alignment of pump parts that will cause excessive wear to rotors, bearings and shafts. Use of thermal expansion (flexible) joints will also minimize forces exerted on the pump. Inlet and outlet valves permit servicing of the pump without emptying the entire system. Inlet piping must not slope toward the pump in such a way as to cause formation of an air pocket ahead of the pump. An inlet valve will serve to keep the inlet line full. This is particularly important with low viscosity fluids and with frequent starts and stops. With low absolute inlet pressure, a check on the outlet side of the pump prevents backflow and minimizes start-up differential pressure.

ATTENTION

CAUTION !

Operation of the pump with inlet and/or outlet valves in the closed position can cause damage to the pump.

4. Welding of fittings is not recommended since warpage can occur which may effect pump operation and performance.
5. Overpressure protection must be provided for this pump. A pump mounted pressure relief valve, a torque limiting device on the drive or a rupture disc in the discharge piping are examples. If pump rotation is to be reversed, pressure protection must be provided on both sides of the pump.



WARNING !

Do not operate pump unless overpressure protection is installed in discharge piping.

6. Inlet side strainers or traps can be used to prevent foreign objects from entering and damaging the pump. Selection should be made based on viscosity to prevent clogging and restricting the inlet thus causing cavitation and reduction of flow from the pump.
7. Installation of pressure and/or vacuum gauges at inlet and/or outlet provide a convenient way to assess pump operation. Such gauges can indicate if pressure is normal or not, show changes in pump or system conditions, and provide indications of flow and changes in viscosity.
8. Pumps and drives ordered from the factory on a common base plate have been supplied with a flexible coupling and aligned before shipping. This alignment should be rechecked after the pump is installed and piping is complete.

To check units coupling alignment begin with checking the angular alignment by measuring the gap between the couplings at four points. Shim the drive assembly accordingly so the gaps are an equal distance at all points (Figure 3). Next check the horizontal and vertical alignment of the couplings using a straight edge. Place the straight edge along the coupling to ensure that both sides are concentric with each other (Figure 4).

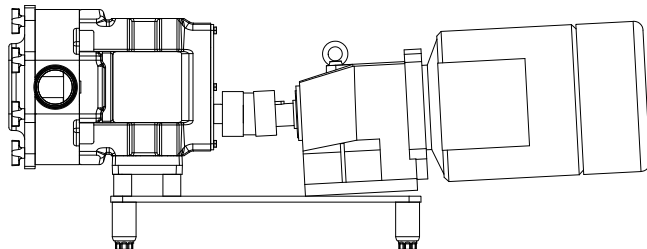

FIGURE 3

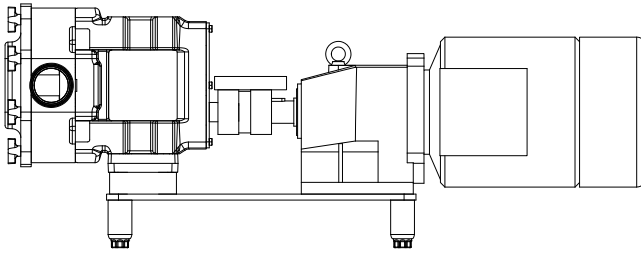

FIGURE 4

- Turn pump shaft manually to make sure that the pump turns freely.

WARNING !
Do not put fingers in ports or near rotating members.

- Jog motor and observe motor coupling to make sure pump will turn in the right direction. See Figure 5.

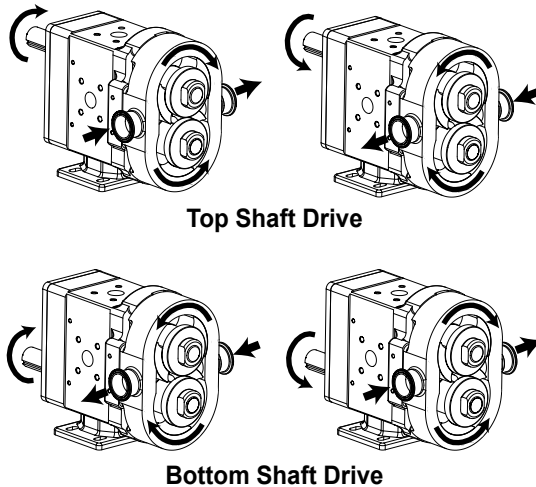

FIGURE 5

WARNING !
Stay clear of motor shaft and coupling when jogging motor.

- Lock out power to pump.
- Connect coupling halves and install coupling guard.

WARNING !
To avoid serious injury or death, do not install or service pump unless power is off and locked out.

- Make sure inlet and outlet connections are tightened. If pump has double seals connect seal flushing piping.

WARNING !
Do not operate pump without guards in place.

WARNING !
Do not put fingers in ports or near rotating members.

These connections are 1/8" NPT pipe threads standard, BSP optional. Liquid used for flushing can be connected to one of the seals and discharged to drain on the opposite side. Flow should be about 1/4 GPM, but may be increased for high temperature applications, but should be kept as near to 1/4 GPM as possible to avoid seal damage. Flush pressure must be kept at or below 14.5 PSI (1 bar).

- Lubrication (Refer to Tables 3 and 4)

Gears are lubricated with oil conforming to ISO 460, SAE 140, AGMA grade 7 or FDA 21 CFR 178.3570 for top or bottom shaft mounting position and oil is added at the factory.

Model	Oil Amount (gears)		Grease Amount (per bearing)	
	Top/Bottom Mount	Side Mount	Front	Rear
0060, 0150, 0180	1.3 oz (40 mL)	3.3 oz (100 mL)	0.37 oz (11 cc)	0.13 oz (4 cc)
0300	2.0 oz (60 mL)	4.0 oz (120 mL)	0.60 oz (18 cc)	0.21 oz (6 cc)
0450, 0600, 1300	6.0 oz (170 mL)	9.5 oz (280 mL)	0.84 oz (25 cc)	0.76 oz (22 cc)
2200	11.0 oz (320 mL)	20.0 oz (600 mL)	1.33 oz (39 cc)	1.03 oz (30 cc)
3200	17.0 oz (500 mL)	44.0 oz (1300 mL)	1.96 oz (58 cc)	1.16 oz (34 cc)

TABLE 3 - LUBRICATING OIL AND GREASE AMOUNT

	Lubricating Oil	Grease
Governing Standard	Conforming to ISO 460 or SAE 140 or AGMA grade 7, and FDA 21 CFR 178.3570.	Conforming to ISO 220 or NLGI grade 2, and NSF USDA-H1
Suggested Brand Names	Chevron Lubricating Oil FM ISO 460	Chevron FM Grease ALC 2 EP
	or equivalent to Governing Standard	or equivalent to Governing Standard

TABLE 4 - SUGGESTED LUBRICATING OIL AND GREASE BRAND

Bearings are greased with grease conforming to ISO 220, NLGI grade 2 or NSF USDA-H1. Add grease to bearings and replace oil for gears every 1,000 hours. Where moisture and/or condensation are heavy change oil and grease more frequently. If temperature is 5°F or below, bearings should be greased with silicon grease.

STARTUP CHECKLIST

- Has protection from high pressure been considered? See Installation, step 5.
- Are pump and all piping clean and free of foreign material, gaskets, weld slag, bolts etc.?
DO NOT USE PUMP TO CLEAN SYSTEM.
- Are connections tightened and leak free?
- Is gear drive properly lubricated? See **Installation**, step 14.
- Are all guards in place and secure?
- Have seals requiring flushing been supplied with an adequate supply of clean flushing fluid?
- Are all valves open on the discharge side of the pump?
- Are all valves open on the inlet side of the pump, and is the material to be pumped reaching the pump?
- Is direction of rotation correct? See **Installation**, step 10.
- Jog or start pump at low speed when possible.

Check to see that pump is performing properly within several minutes. If problems are detected, see Troubleshooting Guide.

CLEANING AND WET-END MAINTENANCE

Wright Flow Technologies products are designed for easy removal of the cover, rotors and seals for cleaning when necessary. See instructions under **Pump Head and Seal Disassembly/Assembly**. Cleaning in place is not recommended.



WARNING !

To avoid serious injury or death, do not install or service pump unless power is off and locked out.



WARNING !

Relieve system pressure before removing cover or port connections.

ATTENTION

CAUTION !

Handle all parts with care to avoid nicks and scratches which may affect pump operation.

Cleaning

Clean per established procedures. Be aware of the cleaning solution used (see MSDS), and of cleaning solution temperature. Make sure no residual cleaning solution stays in the pump.

Note that acidic cleaners have a high metal corrosion rate, so pump parts should be exposed to these cleaners no longer than necessary and be completely rinsed.

Rotor Retainer Seal Replacement Procedure:

1. Remove rotor case cover
2. Remove rotor retainers and ensure components are dry before servicing.
3. With a penlight, inspect shaft threads for contamination. If soiled, refer to cleaning procedure below
4. Install rotor retainer and use a torque wrench to tighten torque setting specified in this manual.
5. Install the rotor case cover and use a torque wrench to tighten cover nuts to torque setting specified in this manual.

Cleaning Procedure for Circumferential Rotor Shaft Threads:

1. Remove rotor retainer devices from the shaft.
2. Submerge and soak retainer part/s for 5 minutes in clean out of place (COP) tank with 2% caustic solution.
3. While wearing the appropriate personal protective equipment (PPE) scrub the part/s vigorously with a sanitary bristle brush for two minutes while submerged.
4. Procure a clean sanitary brush of a size that engages the shaft threads with enough interference to remove contaminants. While wearing the appropriate PPE. Scrub the shaft threads vigorously with the sanitary brush while consistently flushing with a 2% caustic solution using a spray bottle.
5. Soak all above parts in acid sanitizer for 5 minutes, and then scrub again.
6. Flush shaft threads with acid sanitizer for 5 minutes using spray bottle, and then scrub the hole again with the pipe brush for two minutes.
7. Rinse well with clean water and blow-dry blind tapped hole with clean air.
8. Swab test to determine cleanliness.
9. Should the swab test fail, repeat steps 2 thru 8 above until swab test is passed.

PREVENTIVE MAINTENANCE

Simple inspection during cleaning will often detect signs of a problem before it becomes serious so that it can be corrected at minimal cost and down-time.

Remove rotors as described in Step 1 of **Pump Head and Seal Disassembly/Assembly**. Visually inspect rotor wing tips for signs of metal-to-metal contact. If present the pump should be repaired or replaced.

Possible causes:

Worn shaft spline — replace shaft.

Worn rotor spline — replace rotor (usually both parts wear, often due to running a loose rotor).

Loose or worn gears, key, keyway shaft — inspect and replace as needed.

Visually inspect the rotor hub where it contacts the shoulder on the shaft for wear.

Possible cause:

Running loose rotor — replace rotor and correctly tighten or re-shim shaft to maintain backface clearance.

Inspect shoulder on shaft for wear.

Possible cause:

Running loose rotor — replace or re-shim shaft.

Check gear backlash. Replace nuts and turn shaft with wrench. There should be no free movement of either shaft.

Possible causes:

Worn gear teeth — replace gear

Gear loose on shaft — remove gear, inspect key, keyways and shaft. Replace worn parts and retighten.

Check condition of bearings. Hand load (about 30 lbs.) each shaft. There should be no detectable movement.

Cause of movement:

Bearings worn due to lack of lubrication or overload — replace bearings and ensure adequate lubrication, reduce hydraulic load.

If gear box disassembly is required, refer to **Gear Box Disassembly and Assembly**.

When pump is assembled there must be equal clearance where shown. See Figure 6.

Follow lubrication intervals as shown in Tables 3 and 4.

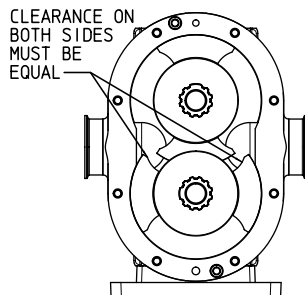

FIGURE 6

ANNUAL MAINTENANCE

Conduct the same checks as above, and in addition do the following:

1. Check bearings for radial play using a dial indicator as shown. If indicator reading is equal to or greater than the rotor to body clearance in Table 6 under **Standard Clearances**, replace bearings. See Figure 7.

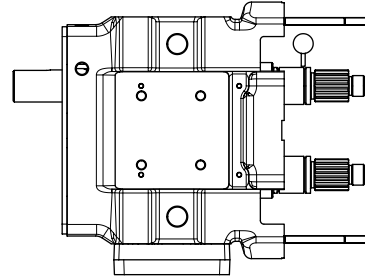

FIGURE 7

2. Drain oil, remove gear box cover and inspect gears for wear, backlash, and looseness. Retighten as needed.
3. Carefully inspect rotors visually for worn splines, bearing shoulder wear, and for stress cracks. Replace worn or cracked rotors. See Figure 8.

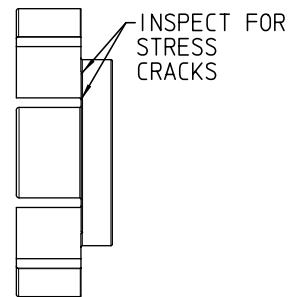

FIGURE 8

4. See Table 6 under **Standard Clearances** and check radial and back face clearance to determine wear.

See **Pump Head and Seal Disassembly/Assembly** for disassembly and assembly. When replacing bearings or shafts in the field care must be taken to properly shim the shaft to provide the correct clearances between the rotors, body and cover.

Operating speed adjustment can compensate for wear in some applications. When performance is no longer acceptable, you may take advantage of the Wright Flow Technologies remanufacturing plan, as follows:

REMANUFACTURING PROGRAM:

Wright Flow TRA10 Pumps may be remanufactured up to four times depending on use and wear. Remanufactured pumps are backed with the same warranty as a new pump. Factory remanufacturing involves body and cover remachining, new rotors, and replacement of all worn parts such as shafts, bearings, gears etc.

To facilitate the remanufacturing process contact the factory to discuss the particular pump(s) to be remanufactured and obtain return goods authorization. It may be possible to supply a reconditioned pump in advance of returning a pump to the factory although not all sizes may be available at any one time. Be sure to clean and flush pump before returning it to the factory.

PUMP HEAD AND SEAL ASSEMBLY AND DISASSEMBLY

Before disassembly, lock out power and release pressure from pump.

WARNING !

To avoid serious injury or death, do not install or service pump unless power is off and locked out.

WARNING !

Relieve system pressure before removing cover or port connections.

ATTENTION

CAUTION !

Handle all parts with care to avoid nicks and scratches which may affect pump operation.

1. PUMP HEAD DISASSEMBLY

Remove wing nuts using a soft hammer. Remove cover. If necessary, tap cover with soft hammer to loosen. Remove and discard cover "O" ring.

Use wrench supplied to remove rotor nuts. Nuts remove in a counter clock-wise direction. Hit wrench sharply with soft hammer to loosen nuts.

Orient rotors perpendicular to each other, then remove rotor with both wings exposed first. If necessary use gear puller or hardwood lever to remove rotor from spline. See Figure 9.

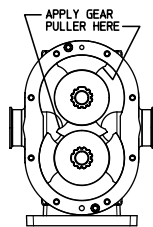

FIGURE 9

If fitted with Allen head hold down bolts in the body remove them, then remove pump body by pulling it straight off studs. Note that the pump body must be assembled to the same bearing housing from which it was removed.

2. SEAL DISASSEMBLY

(For 3200 model pump, consult factory)

Single "O" Ring (See Figure 10)

Remove and discard body and shaft "O" rings. Use "O" ring removal tool furnished with pump.

Double "O" Ring (See Figure 11)

Remove "O" ring carriers; remove and discard rings from both carriers and body. Use "O" ring removal tool furnished.

Single Mechanical Seal (See Figure 12)

Inner Seal:

Remove seal from body. If chipped, scratched or evidence of cracks, discard seal. Make sure shoulder is clean; remove burrs if present; remove and discard "O" rings.

Seal Seat:

Remove seal seat from shaft. If chipped, scratched or evidence of cracks, discard seal. Make sure shoulder is clean; remove burrs if present; remove and discard "O" rings.

Double Mechanical Seal (See Figure 13)

Inner Seal:

Remove seal from body. If chipped, scratched or evidence of cracks, discard seal. Make sure shoulder is clean; remove burrs if present; remove and discard "O" rings.

Outer Seal:

Remove seal from body. If chipped, scratched or evidence of cracks, discard seal. Remove and discard "O" rings.

Seal Seat:

Remove seal seat from shaft. If chipped, scratched or evidence of cracks, discard seal. Make sure shoulder is clean; remove burrs if present; remove and discard "O" rings.

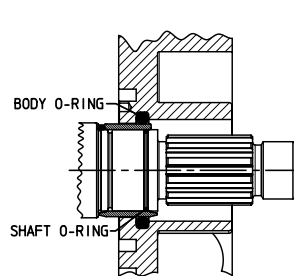

**FIGURE 10
SINGLE "O" RING SEAL**

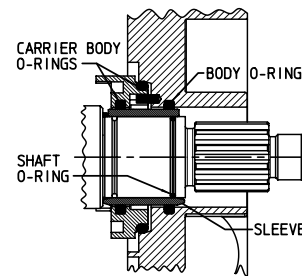

**FIGURE 11
DOUBLE "O" RING SEAL**

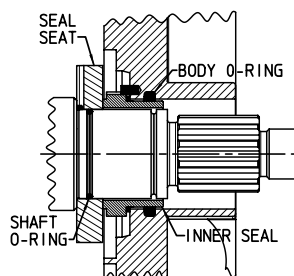

**FIGURE 12
SINGLE MECH. SEAL**

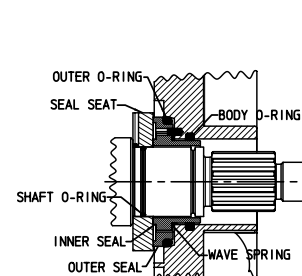

**FIGURE 13
DOUBLE MECH. SEAL**

3. SEAL ASSEMBLY

(For 3200 model pump, consult factory)

Prior to reassembling the pump head inspect all parts to make sure they are free from damage. Nicks, scratches and cracks in mechanical seal components may cause seal leakage, and nicks, scratches and burrs on any pump part may cause leakage or performance problems.

Refer to sketches with disassembly instructions.

Single "O" ring (See Figure 10)

Apply a suitable "O" ring lubricant to new "O" rings and insert them into the body and shaft grooves. "O" rings on shafts should be installed in the groove closest to the spline.

Assemble shaft sleeves against shaft shoulder. If sleeve is slotted, assemble with slot over drive pin in shaft. If sleeve has prongs assemble with prongs on either side of drive pin. Do not re-use sleeves that are grooved or scratched.

Double "O" ring (See Figure 11)

Apply a suitable "O" ring lubricant to new "O" rings and insert them into the body, carrier and shaft grooves. "O" rings on shafts should be installed in the groove closest to the spline when using "O" ring seats. Assemble carriers into body so carrier notch engages pin in body.

Assemble shaft sleeves against shaft shoulder. If sleeve is slotted, assemble with slot over drive pin in shaft. If sleeve has prongs assemble with prongs on either side of drive pin. Do not re-use sleeves that are grooved or scratched.

Single Mechanical Seal (See Figure 12)

Seal Seat:

Apply a suitable "O" ring lubricant to new "O" rings and insert them into shaft grooves furthest from spline.

Install seal seats lining up groove on rear face with shaft drive pin.

Inner Seal:

Apply a suitable "O" ring lubricant to new "O" rings and insert them into body grooves.

Assemble wave spring on seal and install into body with notch engaging pin in body.

Lubricate seal faces.

Double Mechanical Seal (See Figure 13)

Seal Seat:

Apply a suitable "O" ring lubricant to new "O" ring and insert into shaft groove furthest from spline.

Install seal seat lining up groove on rear face with shaft drive pin.

Inner Seal:

Apply a suitable "O" ring lubricant to new "O" ring and insert into body groove.

Assemble wave spring on seal and install into body with notch engaging pin in body.

Outer Seal:

Apply a suitable "O" ring lubricant to new "O" rings and install on outer diameter of seal.

Insert seal assembly into body engaging notch with pin and pushing from opposite side, over and in, to seat "O" ring.

Apply lubricant to seal faces.

Seal Flush Installation (See Figure 14)

Flush holes, threaded for 1/8 NPT, are required on the TRA20 pump for a double o-ring or mechanical seal. Flush media enters the bottom side of the pump and discharges from the top side. Check to ensure flush water is flowing out of the discharge line, before running the pump. Most applications require only a low pressure flush, at a flow rate of approximately 0.25 US GPM.

4. PUMP HEAD ASSEMBLY

Slide body over shafts and studs taking care not to damage seal parts. Press body firmly against gear case engaging dowels. Install Allen Head body hold down bolts, where furnished.

Assemble rotor to its shaft engaging the large spline tooth with large groove in rotor. Rotate shaft until rotor wings are on a vertical centerline, then install second rotor. Secure with rotor retaining nuts: tighten first nut on shaft by striking nut wrench with soft faced hammer, then tighten second nut against first in the same way to jam nuts together.

Place cover "O" ring in groove, push cover over studs making sure "O" ring remains in groove.

Insert a plastic or other soft dowel to clock rotor against pump body, then tighten each nut by striking with a soft hammer.

Sterilize pump in accordance with accepted sterilization procedures. Make sure no residual solution remains in the pump.

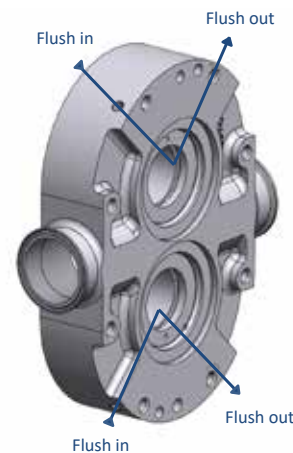

**FIGURE 14
SEAL FLUSH
INSTALLATION**

GEAR BOX DISASSEMBLY AND ASSEMBLY



WARNING !

To avoid serious injury or death, do not install or service pump unless power is off and locked out.



WARNING !

Relieve system pressure before removing cover or port connections.

GEAR BOX DISASSEMBLY

1. Remove pump head as described in step 1 of **Pump Head and Seal Disassembly/Assembly** and drain oil from gear box.
2. Remove cap screws. Remove cover using soft hammer to loosen.
3. Scrape sealant from gear box and cover.
4. Remove oil seal from cover using an arbor press. Discard seal.
5. Using hammer and drift pin straighten locking tab on lockwashers.
6. Prevent shafts from turning by wedging a wooden block between the gears.
7. Use a spanner wrench or drift pin to remove the gear lock nuts.
8. Wrap splines and ends of shafts with tape to protect them.
9. Remove front bearing retainer bolts. Remove sealant from retainers and gear box, press out and discard grease seals. (If retainers are stuck, they will press out when shaft is removed. Refer to cleaning process described above once removed.)
10. Place gear box on arbor press with pump head end down. Protect shaft ends with a wooden block and press shafts out of gear box.
11. Remove shims. If they will be reused identify the shaft on which they were used. Press out and discard rear grease seals.
12. Use hydraulic press and V blocks to remove bearings and spacer. See Figure 16.

GEAR BOX ASSEMBLY

1. Coat front bearing area of shaft with grease conforming to ISO 220, NLGI grade 2 or NSF USDA-H1 and position shaft in hydraulic press with spline down.
2. Place front bearing over shaft with shield side up. Press onto shaft until bearing is seated against shoulder. Place bearing spacer over shaft to seat on front bearing. See Figure 15.

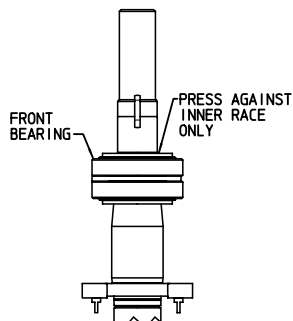

FIGURE 15

3. Coat rear bearing area on shaft with grease conforming to ISO 220, NLGI grade 2 or NSF USDA-H1. Slide rear bearing over shaft with shield side down. Press bearing onto shaft until it seats against spacer. See Figure 16.

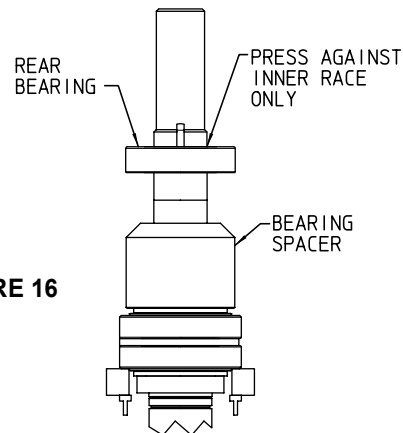

FIGURE 16

4. Wright Flow pumps have close running tolerances to provide efficient operation. The position of the rotors is controlled by the use of shims behind the front bearing in the gear box. These shims control both the backface clearance between the rotors and the bottom of the rotor pocket in the housing and the clearance between the rotors and the cover. See Table 6 under **Standard Clearances** for these dimensions. Clearance for both rotors should be equal to avoid rotor-to-rotor contact. To establish the correct shim thickness, make the following measurements in 0.001 inches:

- A. Measure body width.
- B. Measure depth of rotor bore.
- C. Measure distance from gear box face to bottom of front bearing pocket in gear box.
- D. Slide rotor onto shaft and measure from back of rotor to back of front bearing.

Do calculations for shim thickness:

$$A - B = X$$

$$C + X = Y$$

$$(Y - D) + \text{required backface clearance (from Table 6 under **Standard Clearances**)} = \text{shim thickness.}$$

Repeat measurements for second rotor.

5. Place shim stock in the required thickness against shoulder in the bearing bore.
6. Place gearbox on arbor press with front (pump) end up. Place shaft assemblies in gear box with spline end up and with shafts in the correct location to provide top or bottom drive as required. Press shafts into housing until bearing is seated against shims.
7. Place body on gear box, making sure it is firmly seated. Install rotors on shafts. Secure with rotor retaining nuts: tighten first nut on shaft by striking nut wrench with soft faced hammer, then tighten second nut against first in the same way to jam nuts together. Check back face clearance against value on Table 6 under **Standard Clearances**. If necessary remove rotors, then remove shafts to adjust shim thickness.

- When back face clearance has been established in accordance with the value shown in Table 6, remove body and secure shaft assemblies in the gear box with bearing retainers. Do not apply sealant at this time. Retainers must seat firmly against the bearing and leave .050-.060" clearance between retainer and gear box. Use shims if needed to obtain this clearance. See Figure 17.

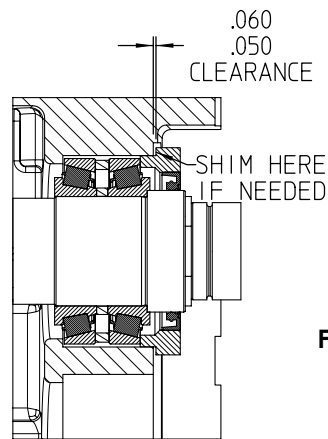

FIGURE 17

- Make sure backface clearance is correct. Remove bearing retainers and grease both front and rear bearings through grease fittings until grease is visible around ball assemblies.
- Install grease seals in bearing retainers. Coat seal lips with grease conforming to ISO 220, NLGI grade 2 or NSF USDA-H1. Coat retainer flanges with silicone sealant. Install retainers. See Figure 18.

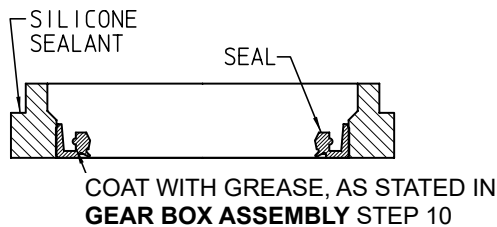
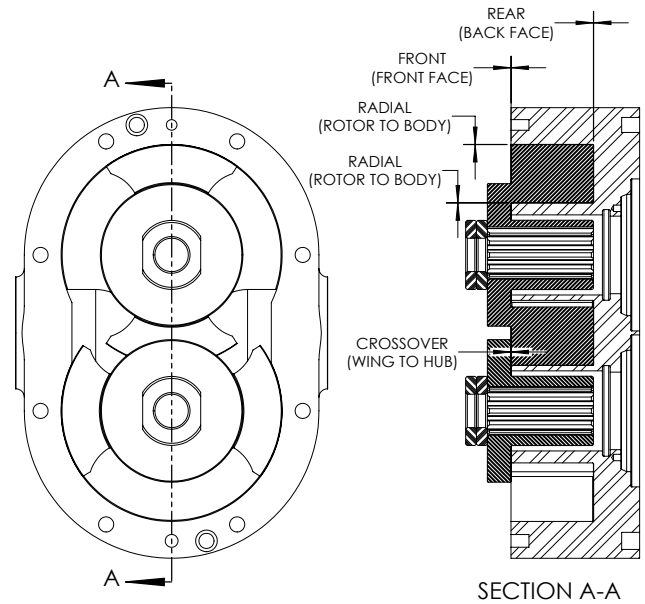

FIGURE 18

- Install rear oil seals and rear gear spacers.
- Please keys into shaft key slots. Slide gear with single punch mark onto drive shaft. Slide gear with two punch marks onto short shaft, with punch marks aligned on each side of single mark of drive gear.
- Install lock washers and lock nuts onto shafts. Tighten locknut with spanner wrench. Bend locking tab on lockwasher to secure.
- Press in gear case cover oil seal with lip facing outward.
- Place silicone sealant on back of gear case and mount cover assembly on gear case. Secure cover.
- Fill gear case with oil as specified in Table 3.

Assemble pump head as described in step 4 of **Pump Head and Seal Disassembly/Assembly**.

STANDARD CLEARANCES



Model	Clearance Type \diamond	Limit	Rotor to Body	Front Face	Back Face	Wing to Hub
0060	Standard	Min	.0010	.0050	.0015	.0045
		Max	.0030	.0060	---	---
	Front Face	Min	.0010	.0065	.0015	.0060
		Max	.0030	.0075	---	---
	Hot	Min	.0035	.0065	.0015	.0060
		Max	.0045	.0075	---	---
	Extra (Hot Choc)	Min	.0050	.0080	.0035	.0075
		Max	.0060	.0090	---	---
	Stainless Steel	Min	.0050	.0080	.0035	.0075
		Max	.0060	.0090	---	---
0150	Standard	Min	.0010	.0050	.0015	.0040
		Max	.0030	.0060	---	---
	Front Face	Min	.0010	.0080	.0015	.0070
		Max	.0030	.0090	---	---
	Hot	Min	.0030	.0080	.0015	.0070
		Max	.0040	.0090	---	---
	Extra (Hot Choc)	Min	.0045	.0090	.0045	.0080
		Max	.0055	.0100	---	---
	Stainless Steel	Min	.0045	.0090	.0045	.0080
		Max	.0055	.0100	---	---
0180 & 0240	Standard	Min	.0010	.0050	.0015	.0055
		Max	.0030	.0060	---	---
	Front Face	Min	.0010	.0070	.0015	.0075
		Max	.0030	.0080	---	---
	Hot	Min	.0035	.0070	.0015	.0075
		Max	.0045	.0080	---	---
	Extra (Hot Choc)	Min	.0045	.0085	.0045	.0090
		Max	.0055	.0095	---	---
	Stainless Steel	Min	.0045	.0085	.0045	.0090
		Max	.0055	.0095	---	---

TABLE 5

STANDARD CLEARANCES (CONT'D)

Model	Clearance Type ◊	Limit	Rotor to Body	Front Face	Back Face	Wing to Hub	
0300 & 0340	Standard	Min	.0010	.0055	.0020	.0045	
		Max	.0040	.0065	---	---	
	Front Face	Min	.0010	.0085	.0020	.0075	
		Max	.0040	.0095	---	---	
	Hot	Min	.0040	.0085	.0020	.0075	
		Max	.0055	.0095	---	---	
	Extra (Hot Choc)	Min	.0045	.0095	.0050	.0085	
		Max	.0060	.0105	---	---	
	Stainless Steel	Min	.0045	.0095	.0050	.0085	
		Max	.0060	.0105	---	---	
	0450	Standard	Min	.0020	.0060	.0030	.0070
			Max	.0060	.0080	---	---
Front Face		Min	.0020	.0100	.0030	.0110	
		Max	.0060	.0120	---	---	
Hot		Min	.0065	.0100	.0030	.0110	
		Max	.0085	.0120	---	---	
Extra (Hot Choc)		Min	.0075	.0110	.0060	.0120	
		Max	.0095	.0130	---	---	
Stainless Steel		Min	.0075	.0110	.0060	.0120	
		Max	.0095	.0130	---	---	
0600 & 0640		Standard	Min	.0030	.0060	.0030	.0055
			Max	.0060	.0080	---	---
	Front Face	Min	.0030	.0100	.0030	.0095	
		Max	.0060	.0120	---	---	
	Hot	Min	.0065	.0100	.0030	.0095	
		Max	.0085	.0120	---	---	
	Extra (Hot Choc)	Min	.0075	.0110	.0060	.0105	
		Max	.0095	.0130	---	---	
	Stainless Steel	Min	.0075	.0110	.0060	.0105	
		Max	.0095	.0130	---	---	

Model	Clearance Type ◊	Limit	Rotor to Body	Front Face	Back Face	Wing to Hub	
1300 & 1340	Standard	Min	.0035	.0055	.0030	.0060	
		Max	.0065	.0075	---	---	
	Front Face	Min	.0035	.0105	.0030	.0110	
		Max	.0065	.0125	---	---	
	Hot	Min	.0070	.0105	.0030	.0110	
		Max	.0090	.0125	---	---	
	Extra (Hot Choc)	Min	.0075	.0125	.0060	.0130	
		Max	.0095	.0145	---	---	
	Stainless Steel	Min	.0075	.0125	.0060	.0130	
		Max	.0095	.0145	---	---	
	2200 & 2240	Standard	Min	.0045	.0075	.0040	.0105
			Max	.0065	.0105	---	---
Front Face		Min	.0045	.0125	.0040	.0155	
		Max	.0065	.0155	---	---	
Hot		Min	.0080	.0125	.0040	.0155	
		Max	.0100	.0155	---	---	
Extra (Hot Choc)		Min	.0090	.0115	.0075	.0145	
		Max	.0110	.0145	---	---	
Stainless Steel		Min	.0090	.0115	.0075	.0145	
		Max	.0110	.0145	---	---	
3200		Standard	Min	.0060	.0085	.0050	.0110
			Max	.0080	.0115	---	---
	Front Face	Min	.0060	.0135	.0050	.0160	
		Max	.0080	.0165	---	---	
	Hot	Min	.0100	.0135	.0050	.0160	
		Max	.0120	.0165	---	---	
	Extra (Hot Choc)	Min	.0100	.0165	.0110	.0190	
		Max	.0120	.0195	---	---	
	Stainless Steel	Min	.0100	.0165	.0110	.0190	
		Max	.0120	.0195	---	---	

TABLE 5 (CONT'D)

TRA10 EXPLODED VIEW

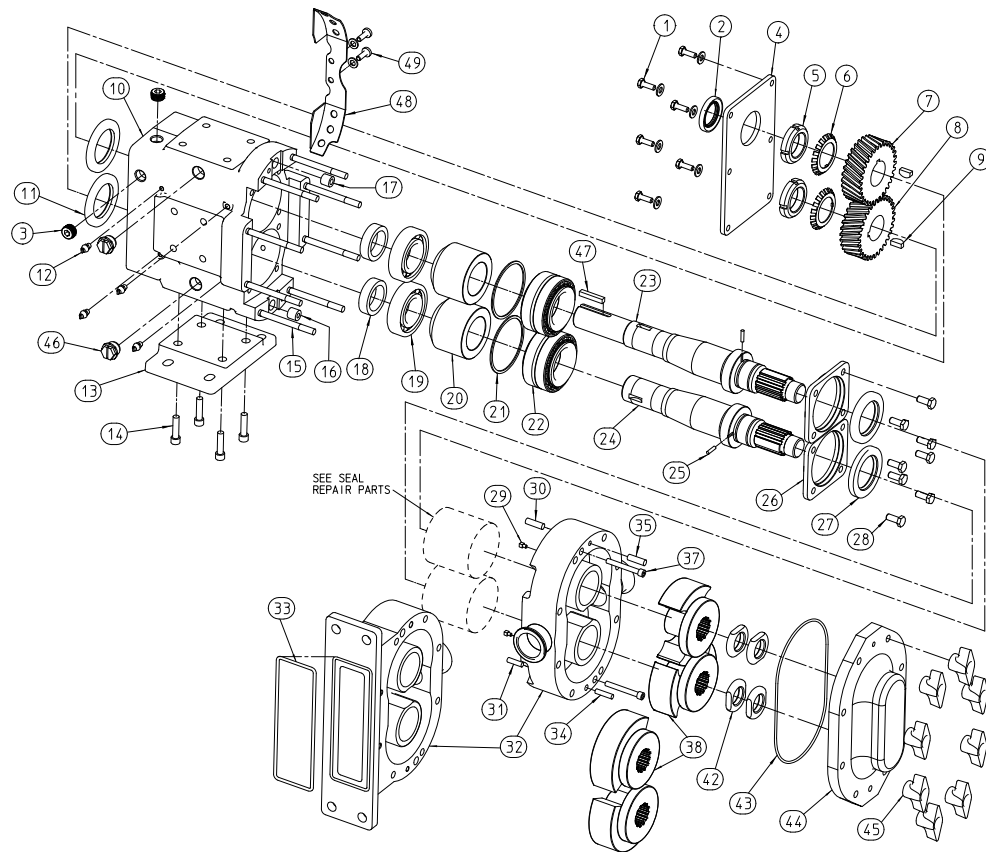

Item	Description	Item	Description
1	Capscrew, Gear Case Cover, SS	25	Rotor Key
1a	Washer GC Cover Capscrew, SS	26	Bearing Retainer Front
2	Oil Seal - Gear Case Cover	27	Grease Seal Front Brg Ret
3	Oil Level, Drain Plug, SS	28	Button Head Capscrew, Brg Ret, SS
4	Gear Case Cover, Steel (Powder Coated, White)	29	Stop Pin, Seal
	Gear Case Cover, Stainless Steel	30	Dowel (upper gear case)
5	Lock Nut - Gear	31	Dowel Pin, Lower Gear Case Side
6	Lock Washer - Gear	32	Pump Body
7	Gear Drive Shaft	33	Rectangular Flange O Ring
8	Gear Short Shaft	34	Dowel Pin, Lower Cover Side
9	Key, Gear	35	Dowel Pin, Upper Cover Side
10	Gear Case, Cast Iron (Powder Coated, White)	36	Rotor Hub O Ring
11	Oil Seal Rear	37	Body Retaining Screw
12	Grease Fitting 1/4-28, SS	38	Twin Blade Rotor, Upper
13	Gear Case Base, Cast Iron (Powder Coated, White)		Single Wing Rotor, Lower
14	Socket Head Capscrew, Mounting Shim, SS	39	Rotor Nut O Ring
15	Stud for Cover	40	Retainer O Ring
16	Dowel Bushing, Lower	41	Washer, Belleville
17	Dowel Bushing, Upper	42	Rotor Nut
18	Spacer Gear to Rear Bearing	43	Cover O Ring
19	Rear Bearing	44	Pump Cover
20	Spacer Bearing	45	Hex Nut
21	Shim Kit	46	Large Cleanout Plug
22	Front Bearing	47	Drive Shaft Key
23	Drive Shaft	48	Seal Guards, SS
24	Short Shaft (17-4PH) Model 0450 TRA20	49	Fastner, Seal Guard

FASTENER TORQUE RANGE

Item No.	Description	Location		0060	0150	0180
45	Wing Nut*	Front Cover to Rotor Case	Qty / Pump	8	8	8
			Size (in)	1-1/4"	1-1/4"	1-1/4"
			Torque (N-m)	7.3-8.6	7.3-8.6	7.3-8.6
			Torque (lbf-ft)	5.4-6.3	5.4-6.3	5.4-6.3
42	Rotor Retainer*	Rotor to Shaft	Qty / Pump	4	4	4
			Size (in)	7/8"-8	7/8"-8	7/8"-8
			Torque (N-m)	5.4-6.8	5.4-6.8	5.4-6.8
			Torque (lbf-ft)	4-5	4-5	4-5
37	Socket Head Cap Screw	Rotor Case to Gearbox	Qty / Pump	2	2	2
			Size (in)	1/4"-20	1/4"-20	1/4"-20
			Torque (N-m)	8.1-9.5	8.1-9.5	8.1-9.5
			Torque (lbf-ft)	6-7	6-7	6-7
28	Cap Screw	Bearing Retainer to Gearbox	Qty / Pump	8	8	8
			Size (in)	1/4"-20	1/4"-20	1/4"-20
			Torque (N-m)	8.1-9.5	8.1-9.5	8.1-9.5
			Torque (lbf-ft)	6-7	6-7	6-7
15	Stud	Front Cover to Gearbox	Qty / Pump	8	8	8
			Size (in)	1/4"-20	1/4"-20	1/4"-20
			Torque (N-m)	8.1-9.5	8.1-9.5	8.1-9.5
			Torque (lbf-ft)	4-5	4-5	4-5
5	Locknut	Drive / Lay Shaft	Qty / Pump	2	2	2
			Size (in)	N-05	N-05	N-05
			Torque (N-m)	67.8-94.92	67.8-94.92	67.8-94.92
			Torque (lbf-ft)	50-70	50-70	50-70
1	Cap Screw	Gearbox Cover	Qty / Pump	6	6	6
			Size (in)	1/4"-20	1/4"-20	1/4"-20
			Torque (N-m)	8.1-9.5	8.1-9.5	8.1-9.5
			Torque (lbf-ft)	6-7	6-7	6-7
14	Socket Head Cap Screw	Mounting Foot	Qty / Pump	4	4	4
			Size (in)	5/16"-18	5/16"-18	5/16"-18
			Torque (N-m)	14.9-16.3	14.9-16.3	14.9-16.3
			Torque (lbf-ft)	11-12	11-12	11-12
49	Socket Head Cap Screw	Finger Guard	Qty / Pump	4	4	4
			Size (in)	#8-32	#8-32	#8-32
			Torque (N-m)	13.56-27.12	13.56-27.12	13.56-27.12
			Torque (lbf-ft)	10-20	10-20	10-20

Item No.	Description	Location		0300	0450	0600
45	Wing Nut*	Front Cover to Rotor Case	Qty / Pump	8	8	8
			Size (in)	2-1/4"	2-1/4"	2-1/4"
			Torque (N-m)	13	68	68
			Torque (lbf-ft)	10	50	50
42	Rotor Retainer*	Rotor to Shaft	Qty / Pump	4	4	4
			Size (in)	1-1/16"-8	1-1/16"-8	1-1/16"-8
			Torque (N-m)	81	102	102
			Torque (lbf-ft)	60	75	75
37	Socket Head Cap Screw	Rotor Case to Gearbox	Qty / Pump	2	2	2
			Size (in)	1/4"-20	3/8"16	3/8"16
			Torque (N-m)	8.1-9.5	27.1-29.8	27.1-29.8
			Torque (lbf-ft)	6-7	20-22	20-22
28	Cap Screw	Bearing Retainer to Gearbox	Qty / Pump	8	8	8
			Size (in)	5/16"-18	3/8"-16	3/8"-16
			Torque (N-m)	14.9-16.3	27.1-29.8	27.1-29.8
			Torque (lbf-ft)	11-12	20-22	20-22
15	Stud	Front Cover to Gearbox	Qty / Pump	8	8	8
			Size (in)	5/16"-18	3/8"-16	3/8"-16
			Torque (N-m)	14.9-16.3	27.1-29.8	27.1-29.8
			Torque (lbf-ft)	9-10	18-20	18-20
5	Locknut	Drive / Lay Shaft	Qty / Pump	2	2	2
			Size	N-07	N-09	N-09
			Torque (N-m)	136	190	190
			Torque (lbf-ft)	100	140	140
1	Cap Screw	Gearbox Cover	Qty / Pump	6	6	6
			Size (in)	1/4"-20	3/8"-16	3/8"-16
			Torque (N-m)	8.1-9.5	27.1-29.8	27.1-29.8
			Torque (lbf-ft)	6-7	20-22	20-22
14	Socket Head Cap Screw	Mounting Foot	Qty / Pump	4	4	4
			Size (in)	3/8"16	1/2"-13	1/2"-13
			Torque (N-m)	27.1-29.8	58.3-63.7	58.3-63.7
			Torque (lbf-ft)	20-22	43-47	43-47
49	Socket Head Cap Screw	Finger Guard	Qty / Pump	8	8	8
			Size (in)	#8-32	#8-32	#8-32
			Torque (N-m)	13.56-27.12	13.56-27.12	13.56-27.12
			Torque (lbf-ft)	10-20	10-20	10-20

* Each shaft of the TRA10 series pump is supplied with two rotor retainers. For proper installation of the rotor retainers, using a properly-sized wrench, screw one retainer onto the shaft and torque to the specified value. Screw the second retainer onto the shaft, torquing to the specified value. Then while holding the wrench to the second retainer, tap the wrench handle with a 16oz. rubber mallet to set the retainer in place.

For proper installation of the cover wing nuts, using a properly-sized wrench, tighten all eight wing nuts to the specified torque value. After the nuts have been tightened, with the wrench on each wing nut, tap the wrench handle with a 16 oz. rubber mallet to set the wing nut in place.

TABLE 6

FASTENER TORQUE RANGE (CONT'D)

Item No.	Description	Location		1300	2200	3200
45	Wing Nut*	Front Cover to Rotor Case	Qty / Pump	8	8	8
			Size (in)	2-1/4"	2-1/4"	2-1/4"
			Torque (N-m)	31	134	193
			Torque (lbf-ft)	23	99	142
42	Rotor Retainer*	Rotor to Shaft	Qty / Pump	4	4	4
			Size (in)	1-1/16"-8	1-9/16"-8	2-1/4"-8
			Torque (N-m)	102	203	258
			Torque (lbf-ft)	75	150	190
37	Socket Head Cap Screw	Rotor Case to Gearbox	Qty / Pump	2	2	2
			Size (in)	3/8"-16	3/8"-16	3/8"-16
			Torque (N-m)	27.1-29.8	27.1-29.8	27.1-29.8
			Torque (lbf-ft)	20-22	20-22	20-22
28	Cap Screw	Bearing Retainer to Gearbox	Qty / Pump	8	8	8
			Size (in)	3/8"-16	3/8"-16	5/16"-18
			Torque (N-m)	27.1-29.8	27.1-29.8	14.9-16.3
			Torque (lbf-ft)	20-22	20-22	11-12
15	Stud	Front Cover to Gearbox	Qty / Pump	8	8	8
			Size (in)	3/8"-16	7/16"-14	5/8"-11
			Torque (N-m)	27.1-29.8	42.0-46.1	124.7-136.9
			Torque (lbf-ft)	18-20	29-32	90-99
5	Locknut	Drive / Lay Shaft	Qty / Pump	2	2	2
			Size	N-09	N-11	N-13
			Torque (N-m)	190	312	434
			Torque (lbf-ft)	140	230	320
1	Cap Screw	Gearbox Cover	Qty / Pump	6	6	6
			Size (in)	3/8"-16	3/8"-16	3/8"-16
			Torque (N-m)	27.1-29.8	27.1-29.8	27.1-29.8
			Torque (lbf-ft)	20-22	20-22	20-22
14	Socket Head Cap Screw	Mounting Foot	Qty / Pump	4	4	4
			Size (in)	1/2"-13	1/2"-13	1/2"-13
			Torque (N-m)	58.3-63.7	58.3-63.7	58.3-63.7
			Torque (lbf-ft)	43-47	43-47	43-47
49	Socket Head Cap Screw	Finger Guard	Qty / Pump	8	8	4
			Size (in)	#8-32	#8-32	#8-32
			Torque (N-m)	13.56-27.12	13.56-27.12	13.56-27.12
			Torque (lbf-ft)	10-20	10-20	10-20

* Each shaft of the TRA10 series pump is supplied with two rotor retainers. For proper installation of the rotor retainers, using a properly-sized wrench, screw one retainer onto the shaft and torque to the specified value. Screw the second retainer onto the shaft, torquing to the specified value. Then while holding the wrench to the second retainer, tap the wrench handle with a 16oz. rubber mallet to set the retainer in place.

For proper installation of the cover wing nuts, using a properly-sized wrench, tighten all eight wing nuts to the specified torque value. After the nuts have been tightened, with the wrench on each wing nut, tap the wrench handle with a 16 oz. rubber mallet to set the wing nut in place.

TABLE 6 (CONT'D)

CARE OF STAINLESS STEEL

Stainless steel components used in products made by Wright Flow Technologies are produced using methods that preserve the corrosion resistant property of stainless steel. The following precautions must be observed in use and cleaning to maintain corrosion resistance:

1. Hydrochloric acid, even with added inhibitors, is **NOT** recommended for cleaning due to its corrosion producing properties.
2. Pitting can occur when stray electrical currents contact wet stainless. Check electrical devices on a regular basis for improper grounding, damaged insulation or other defects that might cause stray currents.
3. Objects in contact with stainless steel prevent the air from drying and reforming the protective oxide film on the stainless, therefore don't leave tools, rubber mats etc. in contact with stainless pump components.
4. Utilize conditioned water where necessary to prevent foreign matter in the water from causing pitting or deposits that may prevent thorough cleaning.
5. Immediately rinse equipment with warm water after use, then clean as soon as possible. Pitting may occur under particles of product left on pump surfaces.
6. Use only recommended cleaning compounds from reputable suppliers, and use only as specified by the manufacturer, to prevent pitting, stress cracking and surface discoloring.
7. Scratches and metal particles embedded into stainless may cause corrosion over time. Use only non-metallic brushes and pads for hand cleaning.
8. Chemical bactericides must be used at the lowest permissible concentration, temperature and time. Follow directions supplied by the manufacturer and local health authority. Chlorine and other halogens may destroy the protective film while increased temperatures increase chemical activity which accelerates corrosion. Inspect joints for properly sealed gaskets in joints; crevices caused by improperly seated gaskets will promote crevice corrosion, particularly in the presence of chlorine.
9. Check all equipment for evidence of pitting and discolored surfaces and for stress cracks. Remove deposits and color from surfaces immediately using mild scouring powder and detergents. Rinse thoroughly and air dry to promote reformation of the protective oxide film.

ASTM A-494

ASTM A-494 is the standard rotor material for TRA10 CPP pumps. This alloy was developed specifically for corrosion resistance and close operating clearance requirements of high performance rotary positive displacement pumps. ASTM A-494 is a nickel based, corrosion-resistant, non-galling or seizing material. The ASTM designation is A-494 Grade CY5SnBiM (UNS N26055), and the material is listed in the 3-A Sanitary Standards as acceptable for product contact surfaces.

The above properties make ASTM A-494 the ideal material for Wright Flow Technologies CPP pumps. The non-galling rotors permit close operating clearances in the liquid end. This provides low slip and minimum shear damage. The rotors will not gall or seize if they come in contact with the body or cover during operation.

The corrosion resistance of ASTM A-494 is approximately equal to AISI 300 Series Stainless Steel. However, ASTM A-494 has limited resistance to certain aggressive chemicals that may be commonly used in contact with AISI 300 Series Stainless Steel.

Do not use ASTM A-494 in contact with nitric acid. Nitric acid is commonly used to passivate new installations of stainless steel equipment. Do not allow nitric acid based passivation chemicals to contact ASTM A-494 rotors. Remove the rotors during passivation and use a separate pump to circulate the passivation chemicals. Also, if nitric acid-based CIP cleaning chemicals are used, remove the rotors prior to CIP cleaning and clean them separately by hand in a mild detergent.

If you have any questions regarding other aggressive chemicals, please contact Wright Flow Technologies Application Engineering for assistance.

ELASTOMER SEAL REPLACEMENT FOLLOWING PASSIVATION

Passivation chemicals can damage product contact areas of Wright Flow Technologies equipment. Elastomers (rubber components) are most likely to be affected. Always inspect all elastomer seals after passivation is completed. Replace any seals showing signs of chemical attack. Indications may include swelling, cracks, loss of elasticity or any other noticeable changes when compared with new components.

TROUBLESHOOTING GUIDE

A properly sized and installed pump should provide trouble free operation, however problems in pumping systems may occur over time. The following information may help in identifying and resolving such problems:

PROBLEM	POSSIBLE CAUSE(S)	SOLUTION(S)
Pump not turning	Drive motor not running	Check circuit breakers, fuses
	Keys sheared or missing	Replace keys
	Drive belts, etc. slipping or broken	Adjust or replace
	Shaft or gears sheared	Replace
No flow, pump turning	Rotation in wrong direction	Reverse rotation
No flow, pump not priming	Inlet valve closed	Open valve
	Inlet line clogged	Clean line and filters
	Air leaks because of bad seals and/or pipe connections	Replace seals, pressurize lines to check for leakage
	Speed of pump too slow	Increase speed, fill inlet lines, install foot valve
	Liquid drains or siphons	Install foot or check valves
	Air lock due to fluids that may vaporize or allow gas to come out of solution	Install air bleed in lines near pump
	Excess clearance between rotors and body and cover	Increase pump speed, install foot valve, have pump rebuilt
	Net inlet pressure too low	Check Net Inlet Pressure Available at Pump and Net Inlet Pressure Required by Pump. Calculate system and modify inlet system as needed.
No flow	With vacuum inlet system, atmospheric "blow back" prevents pump from starting flow	Install check valve in discharge line
	Relief valve not properly adjusted or held open by foreign material	Adjust or clear valve
Fluid vaporization (starved Pump inlet)	Filters, valves, inlet filters or lines clogged	Clean
	Inlet line too small or too long, too many valves or fittings, filter too small	Make necessary changes
	Net Inlet Pressure Available at Pump too low	Increase level in source tank or pressurize tank Select larger pump with less inlet pressure required
	Viscosity of pump fluid higher than anticipated	Reduce pump speed (lower flow will result) or modify system
	Temperature of fluid higher than anticipated	Provide cooling, reduce speed, modify system to increase available inlet pressure
Insufficient flow	Speed too low	Increase speed
	Air leaks because of bad seals and/or pipe connections	Replace seals, pressurize lines to check for leakage
Relief valve not adjusted or held	Adjust/clean	Open
	Flow diverted in system	Check system valves and controls
	Hot clearance rotors used with "cold" or low viscosity fluid	Replace with standard rotors
	Worn pump	Increase speed, recondition pump
	Pressure too high	Modify system
Noisy operation	Cavitation due to high fluid Viscosity, high vapor pressure or high temperature	Reduce speed and/or temperature, modify system
	Inlet Pressure Available less than Inlet Press Required	Modify System
	Air or gas in system due to system leaks	Fix leaks
	Dissolved gas or naturally aerated products	Reduce discharge pressure, reduce speed and/or temperature, modify system
	Rotor to body contact	Check back face and rotor to cover clearances and reshim as necessary Check for distortion of pump due to Installation of piping. Reassemble pump and/or re-install piping
	Pressure higher than pump is Rated	Reduce pressure
	Worn bearings or gears	Replace as needed, ensure regular lubrication
	Rotor to rotor contact noise due to twisted shaft, sheared keys, loose or mistimed gears, worn splines	Rebuild with new parts as needed
	Relief valve chattering	Readjust, repair or replace valve
	Drain train components	Lubricate, repair or replace as needed
Pump overheats, stalls, draws excessive current (trips breaker, blows fuses)	Higher viscous losses than anticipated	If pump is within rating, increase drive size
	Pressure higher than anticipated	Reduce speed, increase line size
	Fluid colder than anticipated, high viscosity	Heat fluid/insulate and heat lines, increase running clearances
	Fluid sets up during shutdown	Insulate or heat lines, install recirculating or "soft start" drive, Flush with different fluid
	Fluids such as chocolate, latex build up on internal pump surfaces	Increase running clearances
Pump service life not as long as expected	Misalignment of drive and piping, excessive pump overhang	Align piping and drive
	Abrasive fluid	Use larger pump at slower speed
	Bearings and gears lack lubrication	Establish and follow lubrication schedule
	Speeds and pressures higher than pump is rated	Reduce speed and pressures by system modification
	Pump corrodes	Upgrade material used in pump

FOR ATEX PUMPS ONLY

INCORRECT INSTALLATION, OPERATION, OR MAINTENANCE OF EQUIPMENT MAY CAUSE SEVERE PERSONAL INJURY OR DEATH AND/OR EQUIPMENT DAMAGE AND MAY INVALIDATE THE WARRANTY.

This information must be read fully before beginning installation, OPERATION, or maintenance and must be kept with the pump. **SUITABLY TRAINED OR QUALIFIED PERSONS MUST UNDERTAKE ALL INSTALLATION AND MAINTENANCE** only.

DANGER !

Failure to follow the listed precautionary measures may result in serious injury or death as identified by the following symbol: 

 Insure that the pump is grounded (earthed) with the connection provided and that the motor, gear reducer, base plate and other components are adequately grounded. Failure to ground equipment may result in an explosion causing death or serious injury.

 Wright ATEX pumps are sold to be coupled with a motor, and usually be mounted on a base plate. The motor, other electrical equipment, gear reducers, couplings, guards and base plates must comply with ATEX requirements. The motor, gear reducer, sensors, and other associated electrical equipment must bear CE and ATEX marking. Couplings must be ATEX marked, and be accompanied by a Certificate of Conformity. Failure to comply will void ATEX Certification and may result in an explosion causing death or serious injury.

 Provide a means to monitor all sensing equipment. Failure to do so may cause unacceptable build up of temperature or pressure which could result in an explosion causing death or serious injury.

 Install ATEX conforming guards as required to meet EC Directives.

 Conduct all maintenance activities as detailed in the pump manual. Failure to do so may cause pump failure could result in an explosion causing death or serious injury.

ATEX EQUIPMENT GROUPS

Equipment - groups (Annex I of the EC-Directive 94/9/EC)							
Group I (mines, mine gas and dust)		Group II (other explosive atmospheres gas/dust)					
Category M		Category 1		Category 2		Category 3	
1	2	G (gas) (Zone 0)	D (dust) (Zone 20)	G (gas) (Zone 1)	D (dust) (Zone 21)	G (gas) (Zone 2)	D (dust) (Zone 22)
for equipment providing a very high level of protection when endangered by an explosive atmosphere	for equipment providing a high level of protection when likely to be endangered by an explosive atmosphere	for equipment providing a very high level of protection when used in areas where an explosive atmosphere is very likely to occur		for equipment providing a high level of protection when used in areas where an explosive atmosphere is likely to occur		for equipment providing a normal level of protection when used in areas where an explosive atmosphere is less likely to occur	

ATEX TAG USED ON WRIGHT ATEX CERTIFIED PUMPS

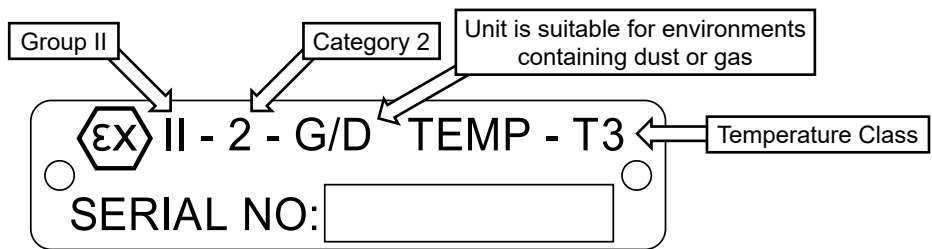

FOR ATEX PUMPS ONLY

RISK ASSESSMENT RELATING TO THE USE OF WRIGHT PUMPS IN POTENTIALLY EXPLOSIVE ATMOSPHERES

Note: For a product to be suitable for an application it must be fit for its designated purpose and also be suitable for the environment where it is installed.

Source Of Hazards	Potential Hazards	Frequency Of Hazards	Recommended Measures
Unvented cavities	Build up of explosive gas	Very Rare	Ensure that pump is totally filled. Consider mounting ports vertically.
Housing / Rotors / Impellers / Front Cover / Backplate	Unintended mechanical contact	Rare	Ensure that operating pressures are not exceeded. Ensure that sufficient NPSH to prevent cavitation. Service plan.
Pump external surfaces	Excess temperature. Electrostatic charging.	Rare	User must ensure temperature limits. Do not overfill gearboxes with lubricant. Provide a ground contact for pump. Service plan.
Housing / Cover 'O' ring	Pump liquid leakage. Build up of explosive gas.	Very Rare	Check selection of elastomers are suitable for application. Ensure cover retaining nuts are tight. Service plan.
Pump housing / cover / Impeller / Backplate	Pump liquid leakage. Build up of explosive gas.	Very Rare	Corrosion resistant materials.
Shaft seals	Excess temperature. Unintended mechanical contact. Leakage. Build up of explosive gas.	Rare	Selection of seal system must be suitable for application. Service as needed. Always provide seal flush when so equipped.
Rotation direction test	Excess temperature	Very Rare	Ensure liquid is in pump chamber before testing / Always provide seal flush when so equipped. Allow pump to run for minimum period - a few seconds / See Manual
Closed valve condition	Excess Temperature. Excess Pressure. Mechanical contact.	Rare	Provide over-pressure protection. See Manual.
Shaft	Random induced current	Very Rare	Provide a ground contact for pump.

NOTES

WARRANTY

Wright Flow Technologies warrants all products manufactured by it to be free from defects in workmanship or material for a period of one (1) year from date of startup, provided that in no event shall this warranty extend more than eighteen (18) months from the date of shipment from Wright Flow Technologies. If, during said warranty period, any products sold by Wright Flow Technologies prove to be defective in workmanship or material under normal use and service, and if such products are returned to Wright Flow Technologies' factory at Cedar Falls, Iowa, transportation charges prepaid, and if the products are found by Wright Flow Technologies to be defective in workmanship or material, they will be replaced or repaired free of charge, FOB. Cedar Falls, Iowa.

Wright Flow Technologies assumes no liability for consequential damages of any kind and the purchaser by acceptance of delivery assumes all liability for the consequences of the use or misuse of Wright Flow Technologies products by the purchaser, his employees or others. Wright Flow Technologies will assume no field expense for service or parts unless authorized by it in advance.

Equipment and accessories purchased by Wright Flow Technologies from outside sources which are incorporated into any Wright Flow Technologies product are warranted only to the extent of and by the original manufacturer's warranty or guarantee, if any.

THIS IS WRIGHT FLOW TECHNOLOGIES' SOLE WARRANTY AND IS IN LIEU OF ALL OTHER WARRANTIES, EXPRESSED OR IMPLIED, WHICH ARE HEREBY EXCLUDED, INCLUDING IN PARTICULAR ALL WARRANTIES OF MERCHANTABILITY OR FITNESS FOR A PARTICULAR PURPOSE. No officer or employee of IDEX Corporation or Wright Flow Technologies, Inc. is authorized to alter this warranty.

EUROPE & ASIA:

Wright Flow Technologies Ltd.
Highfield Industrial Estate, Edison Road Eastbourne
East Sussex, United Kingdom, BN23 6PT
Phone: +44(0)1323 509211 • **Fax:** +44(0)1323 507306
E-mail: wright.eu@idexcorp.com

AMERICAS:

Wright Flow Technologies, Inc.
406 State Street
Cedar Falls, Iowa 50613 U.S.A.
Phone: (319) 268-8013 • **Fax:** (803) 216-7686
E-mail: wright.usa@idexcorp.com

www.wrightflowtechnologies.com